

Racores y accesorios OX1 para aplicaciones de gases medicinales

Nuevo

Diámetro externo de tubo: 4, 6 y 8 mm

Roscas: métrico (M5), cilíndrico (G1/8, G1/4), cónico (R1/8, R1/4)



Los racores OX1 están diseñados para el mercado de Ciencias de la Vida, en especial para aplicaciones médicas y analíticas. Los fabricantes de equipos de ventiladores, dispositivos de anestesia, concentradores de oxígeno, espectrometría de masas o analizadores biomédicos han calificado los accesorios de la Serie OX1 durante muchos años.

Nivel de limpieza de los productos OX1: Residuo no volátil igual o menor que 550 mg/m²
Nivel OX1: limpieza ultrasónica de los componentes, inspección con luz negra UV, lubricación con una grasa específica adecuada para usar con oxígeno.

- » Limpieza ultrasónica
- » Grasa adecuada al oxígeno
- » Sistema de sujeción de pinza para un sellado óptimo
- » Largo ciclo de vida
- » Usar con tubos PA, PU, PE o de Fluoropolímero

Racores roscados Serie 6000 OX1:

Los racores roscados super rápidos Serie 6000 OX1 fueron diseñados con una pinza especial que proporciona una estabilidad homogénea en toda la superficie de los tubos de plástico. De este modo garantiza una alta fiabilidad y un largo ciclo de vida, aunque se repitan varias veces las conexiones y desconexiones del tubo.

Válvulas unidireccionales Serie VNR OX1:

Disponibles con racores de enchufe rápido. Gracias a su construcción operan a baja presión.

Racores de tuberías de latón Serie 2000 OX:

La amplia gama de racores accesorios de Camozzi, que incluye los modelos recto, L y T, macho o hembra, garantiza el apoyo necesario durante el diseño de sistemas médicos y analíticos.

CARACTERÍSTICAS GENERALES

Serie 6000	
Diámetros	ø 4, 6 y 8mm
Roscas	GAS cilíndrico ISO 228 (cilíndrico); M5
Temperatura	-15 °C ÷ 80 °C (ver información técnica de tubería usada)
Tubo para conectar	Poliamida (PA) 6 - 11 - 12, Poliuretano (PU), Fluoropolímero (FEP)
Fluidos	Oxígeno, Gases medicinales, Aire Comprimido u Otros fluidos de baja presión
Materiales	Modelos estándar: cuerpo y pinza en latón niquelado, junta tórica con FKM con grasa adecuada al oxígeno.
Presión de trabajo	Modelos estándar: mín. -0,9 bar - máx. 16 bar (ver tubería)

Serie VNR	
Grupo de válvulas	válvulas automáticas
Construcción	válvula de asiento
Materiales	cuerpo de latón resorte de acero inoxidable juntas FKM
Montaje	en cualquier posición
Dimensiones de tubo	Ø4; Ø6; Ø8
Temperatura de funcionamiento	0 °C ÷ 80 °C
Fluidos	Oxígeno, Gases medicinales, Aire Comprimido u Otros fluidos de baja presión

Serie 2000	
Roscas	GAS cónico ISO 7 (cónico) GAS cilíndrico ISO 228 (cilíndrico)
Temperatura	-40 °C ÷ 120 °C
Fluidos	Oxígeno, Gases medicinales, Aire Comprimido u Otros fluidos de baja presión
Materiales	latón niquelado
Presión de trabajo	80 bar

Racores Mod. 6512-OX1

Nuevo

Conector Macho Métrico - cilíndrico

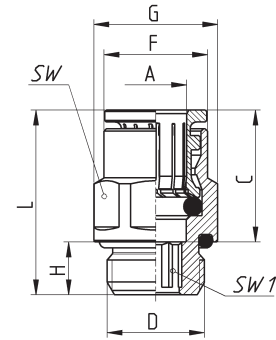

DIMENSIONES										
Mod.	A	D	C	F	G	H	L	SW	SW1	Peso (g)
6512 4-M5-OX1	4	M5	14.0	7.8	8.8	4	20	8	2	4
6512 4-1/8-OX1	4	G1/8	14.0	8.8	13.5	6	19	12	2.5	10
6512 6-M5-OX1	6	M5	16.0	11.7	13.2	4	22	12	2	8
6512 6-1/8-OX1	6	G1/8	16.0	11.7	13.5	6	21	12	4	10
6512 6-1/4-OX1	6	G1/4	16.0	11.7	16.4	7	22	15	4	13
6512 8-1/8-OX1	8	G1/8	17.5	13.7	15.2	6	26	14	5	15
6512 8-1/4-OX1	8	G1/4	17.5	13.7	16.4	7	24.5	15	6	17

Racores Mod. 6700-OX1

Nuevo

Cartucho

S* = para base metálica y sintética

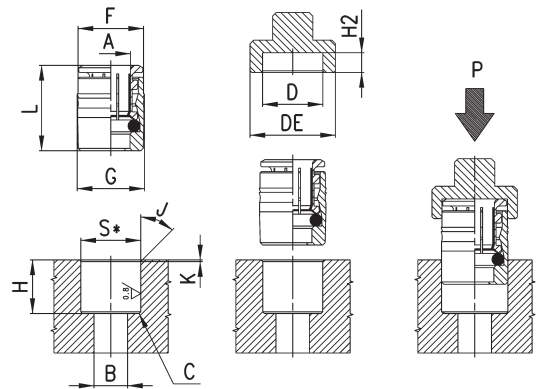

Mod.	A	B	C	D	DE	F	G	H	H2	J	K	L	P mín	P máx	S (+0,01/-0,04)	Peso (g)
									(+0,1/0)				(Kg)	(Kg)		
6700 4-OX1	4	3.5	0.5x45°	8.8	14	8.6	9	11	3.3	15°	0.5	14.5	200	360	8.75	4
6700 6-OX1	6	4	0.5x45°	12	17	11.8	12.2	12	3.8	15°	0.5	16.5	160	570	11.95	8

Racores Mod. 6463-OX1

Nuevo

Conector Hembra Métrico - cilíndrico

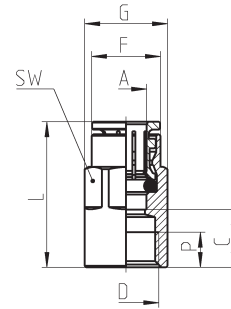

DIMENSIONES										
Mod.	A	D	C	F	G	L	P (mín)	SW	Peso (g)	
6463 4-1/8-OX1	4	G1/8	10	9	13	24	6	12	14	
6463 6-1/8-OX1	6	G1/8	10	11.7	13	26	6	12	14	
6463 6-1/4-OX1	6	G1/4	11.5	11.9	16.5	27.5	7	15	23	

Racores Mod. 6522-OX1

Nuevo

Codo Macho Giratorio Métrico - cilíndrico

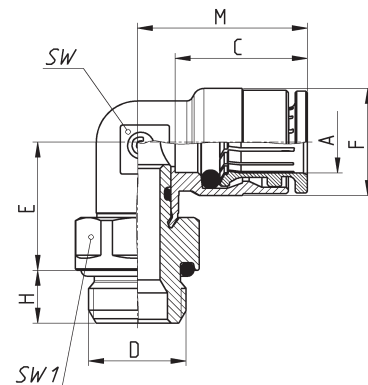

DIMENSIONES										
Mod.	A	D	C	E	F	H	M	SW	SW1	Peso (g)
6522 4-M5-OX1	4	M5	14.0	12.5	9	4	17.5	8	8	12
6522 4-1/8-OX1	4	G1/8	14.0	14.5	9	6	17.5	8	12	15
6522 6-M5-OX1	6	M5	16.0	13	12.7	4	20	9	10	14
6522 6-1/8-OX1	6	G1/8	16.0	15	12.7	6	20	9	12	19
6522 6-1/4-OX1	6	G1/4	16.0	16	12.7	7	20	9	15	27
6522 8-1/8-OX1	8	G1/8	17.5	16	14.2	6	22.5	11	12	22
6522 8-1/4-OX1	8	G1/4	17.5	17	14.2	7	22.5	11	15	28

Racores Mod. 6590-OX1

Nuevo

Pasamuros

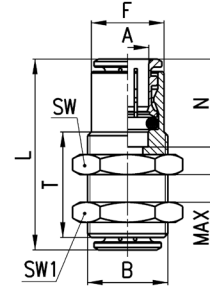

DIMENSIONES										
Mod.	A	B	F	L	N	MAX	SW	SW1	T	Peso (g)
6590 4-OX1	4	M10x1	8.8	29	14	10.5	14	14	20	16
6590 6-OX1	6	M14x1	12.5	33	16	10.5	17	17	20	28

Racores Mod. 6580-OX1

Nuevo

Conector de unión

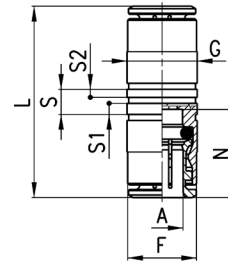

DIMENSIONES									
Mod.	A	F	G	L	N	S	S1	S2	Peso (g)
6580 4-OX1	4	8.4	9	29	14	5	2.2	1.6	11
6580 6-OX1	6	11.7	12	34	16	5	2.2	1.6	16
6580 8-OX1	8	13.7	14	37	17.5	5	2.2	1.6	23

Racores Mod. 6550-OX1

Nuevo

Conector de codo

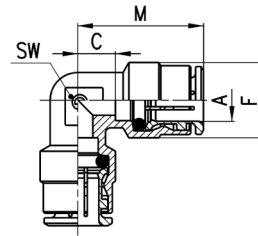

DIMENSIONES						
Mod.	A	C	F	M	SW	Peso (g)
6550 4-OX1	4	3.5	9	17.5	8	8
6550 6-OX1	6	4	12.7	20	9	17

Racores Mod. 6540-OX1

Nuevo

Conector en T

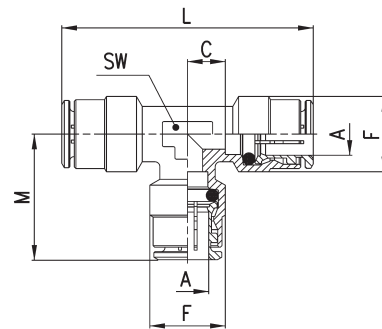

DIMENSIONES							
Mod.	A	C	F	L	M	SW	Peso (g)
6540 4-OX1	4	3.5	9	35	17.5	8	14
6540 6-OX1	6	4	12.7	40	20	9	24

Racores Mod. 6560-OX1

Nuevo



Unión en Y

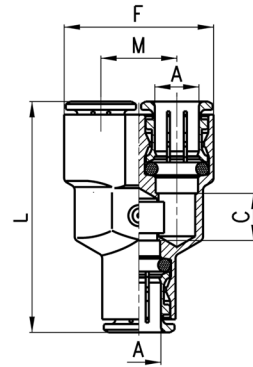

DIMENSIONES						
Mod.	A	C	F	L	M	Peso (g)
6560 4-OX1	4	5	18	33	9	19
6560 6-OX1	6	7	24.5	39	12.5	30

Racores Mod. 6750-OX1

Nuevo



Tapón Hembra

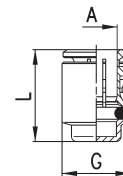

DIMENSIONES				
Mod.	A	G	L	Peso (g)
6750 4-OX1	4	8.8	15	4
6750 6-OX1	6	11.8	17	7

Racores Mod. 6800-OX1

Nuevo



Reductor

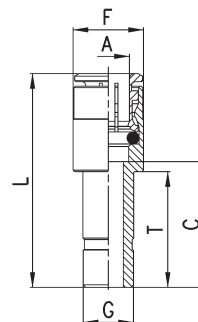

DIMENSIONES							
Mod.	A	G	C	F	L	T	Peso (g)
6800 4-6-OX1	4	6	15.5	9	29.5	18	9
6800 4-8-OX1	4	8	18	9	32	20.5	10
6800 6-8-OX1	6	8	18	12.7	34	20.5	12

Racores Mod. 6555-OX1

Nuevo



Codo de unión

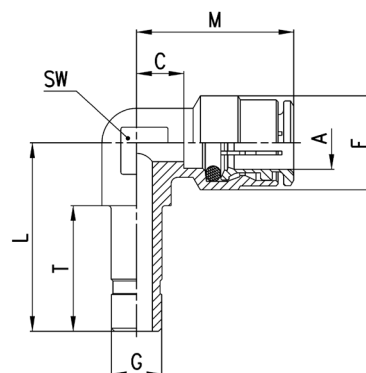

DIMENSIONES									
Mod.	A	G	C	L	F	T	M	SW	Peso (g)
6555 6-6-OX1	6	6	4	24.5	12.7	18	20	9	14

Accesorio Mod. 6900-OX1

Nuevo



Tapón Macho de Plástico

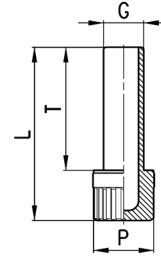

DIMENSIONES					
Mod.	G	L	P	T	Peso (g)
6900 4-OX1	4	29	8	20	1
6900 6-OX1	6	31.5	8	22.5	1

RACORES Y ACCESORIOS OX1 PARA APLICACIONES CON GASES MEDICINALES

Válvulas unidireccionales Serie VNR

Nuevo

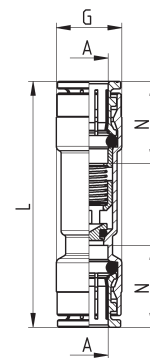

Mod.	A	G	L	N	Flujo 6 bar $\Delta P1$ (Nl/min)	Presión de funcionamiento mín. (bar)	Presión de funcionamiento máx. (bar)	Peso (g)
6580 4-VNR-OX1	4	9	40	14	85	0,2	10	13
6580 6-VNR-OX1	6	12	48	16	450	0,2	10	20
6580 8-VNR-OX1	8	14	52.5	17.5	900	0,2	10	30

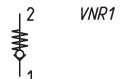

Racores Mod. 2500-OX1

Nuevo

Unión M-M cónico

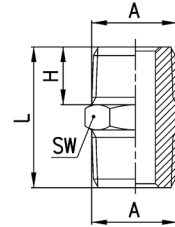

DIMENSIONES					
Mod.	A	H	L	SW	Peso (g)
2500 1/8-OX1	R1/8	7,5	19,5	12	9
2500 1/4-OX1	R1/4	11	27	14	16

Racores Mod. 2501-OX1

Nuevo

Unión M-M cilíndrico

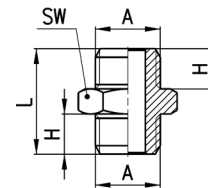

DIMENSIONES					
Mod.	A	H	L	SW	Peso (g)
2501 1/8-OX1	G1/8	6	16,5	13	9
2501 1/4-OX1	G1/4	8	21	17	15

Racores Mod. 2510-OX1

Nuevo

Reducción M-M cónico

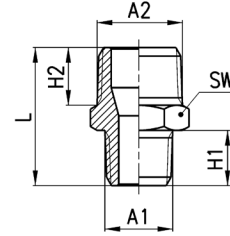

DIMENSIONES							
Mod.	A1	A2	H2	H1	L	SW	Peso (g)
2510 1/8-1/4-OX1	R1/8	R1/4	11	7,5	23,5	14	14

Racores Mod. 2531-OX1

Nuevo

Reductor cilíndrico

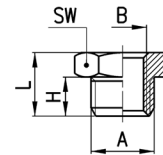

DIMENSIONES							
Mod.	A	B	H	L	SW	Peso (g)	
2531 1/8-M5-OX1	G1/8	M5	6	10,5	13	8	*
2531 1/4-1/8-OX1	G1/4	G1/8	8	13	17	11	*

* = con rosca pasante

Racores Mod. 2543-OX1

Nuevo

Unión Hembra

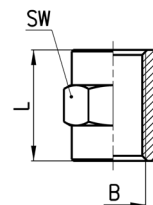

DIMENSIONES				
Mod.	B	L	SW	Peso (g)
2543 M5-OX1	M5	11	8	3
2543 1/8-OX1	G1/8	15	13	8
2543 1/4-OX1	G1/4	22	17	19

Racores Mod. 2611-OX1

Nuevo

Tapón Macho cilíndrico

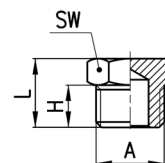

DIMENSIONES					
Mod.	A	H	L	SW	Peso (g)
2611 M5-OX1	M5	4	7,5	8	2
2611 1/8-OX1	G1/8	6	10,5	13	7
2611 1/4-OX1	G1/4	8	13	17	13

Racores Mod. 2013-OX1

Nuevo

Codo Hembra cónico

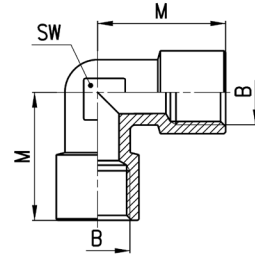

DIMENSIONES				
Mod.	B	M	SW	Peso (g)
2013 1/8-OX1	G1/8	19	11	16
2013 1/4-OX1	G1/4	23	14	28

Racores Mod. 2021-OX1 y 2020-OX1

Nuevo

Mod. 2021-OX1: Codo Macho Hembra Métrico
Mod. 2020-OX1: Codo Macho Hembra cónico

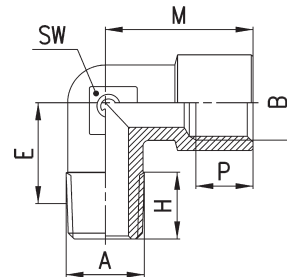

DIMENSIONES								
Mod.	A	B	E	H	M	P (mín)	SW	Peso (g)
2020 1/8-1/8-OX1	R1/8	G1/8	11,5	8,5	19	6	11	17
2020 1/4-1/4-OX1	R1/4	G1/4	15	11	23	7	13	27

Racores Mod. 2003-OX1

Nuevo

T Hembra

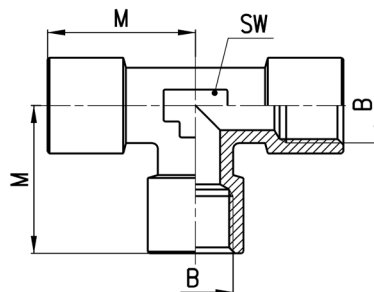

DIMENSIONES				
Mod.	B	M	SW	Peso (g)
2003 1/8-OX1	G1/8	19	12	23
2003 1/4-OX1	G1/4	23	13	39

RACORES Y ACCESORIOS OX1 PARA APLICACIONES CON GASES MEDICINALES

Racores Mod. 2043-OX1

Nuevo

Y Hembra

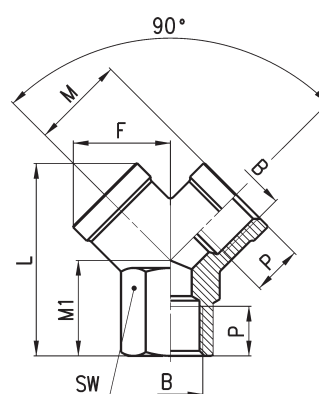

DIMENSIONES								
Mod.	B	F	L	M	M1	P	SW	Peso (g)
2043 1/8-OX1	G1/8	14,5	26,5	14	12	8	13	18
2043 1/4-OX1	G1/4	18	32	17,5	14	11	17	32

Racores Mod. 2013-OX1

Nuevo

Codo Hembra cónico

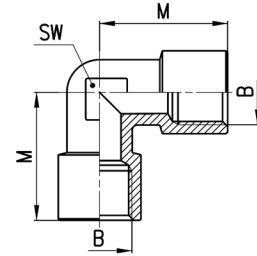

DIMENSIONES				
Mod.	B	M	SW	Peso (g)
2013 1/8-OX1	G1/8	19	11	16
2013 1/4-OX1	G1/4	23	14	28

Racores Mod. 2021-OX1 and 2020-OX1

Nuevo

Mod. 2021-OX1: Codo Macho Hembra Métrico
Mod. 2020-OX1: Codo Macho Hembra cónico

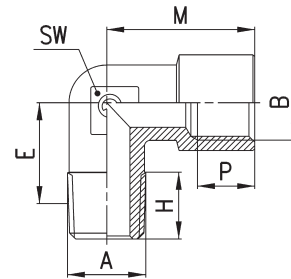

DIMENSIONES								
Mod.	A	B	E	H	M	P (mín)	SW	Peso (g)
2020 1/8-1/8-OX1	R1/8	G1/8	11,5	8,5	19	6	11	17
2020 1/4-1/4-OX1	R1/4	G1/4	15	11	23	7	13	27

Racores Mod. 2003-OX1

Nuevo

T Hembra

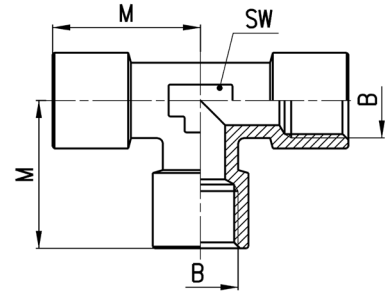

DIMENSIONES				
Mod.	B	M	SW	Peso (g)
2003 1/8-OX1	G1/8	19	12	23
2003 1/4-OX1	G1/4	23	13	39

Racores Mod. 2043-OX1

Nuevo

Y Hembra

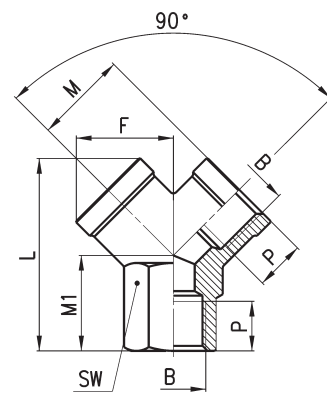

DIMENSIONES								
Mod.	B	F	L	M	M1	P	SW	Peso (g)
2043 1/8-OX1	G1/8	14,5	26,5	14	12	8	13	18
2043 1/4-OX1	G1/4	18	32	17,5	14	11	17	32